



Project :

Type :

Part#:

LED Flood Light

P/N: INS-LFL61-35WXYZA1-abcd

Note:

INS = Company name

LFL61 = Product series, LED Flood Light

35W = Rating Power;

B=LED manufacturer,Lumileds 2835;

CG=Clear Glass;

D=Double color temperature;

A1 = Version number;

"a" can be any two letters for lamp colors;

"b" can be "AM" or "YM" for Mounting Means;

"c" can be "P"for photocontrol or blank for no Photocontrol provided;

"d" can be any digits for CCT.

30=3000K,40=4000K,50=5000K;

ADVANTAGE

- UL cUL certificate.
- IP65 driver, input voltage 120-277VAC
- No UV or IR in the beam.
- Easy to install and operate.
- Energy saving, long lifespan.
- Light is soft and uniform, safe to eyes.
- Instant start, NO flickering, NO humming.
- Green and eco-friendly without mercury.

APPLICATION

- Outdoor basketball court, tennis court.
- Badminton court, the football field.
- The school playground, stadium.
- Community leisure entertainment plaza,
- Warehouse,factory and workshops;
- Highway toll station;
- Meeting room, exhibition hall;
- Gymnasium and supermarkets, etc. plaza,
- Warehouse,factory and workshops;
- Highway toll station;
- Meeting room, exhibition hall;
- Gymnasium and supermarkets, etc.



AM



YM

DIMENSION

AM

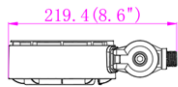
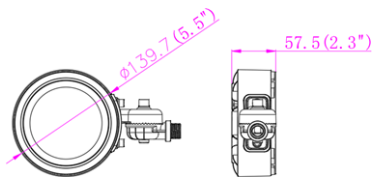

YM

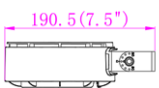
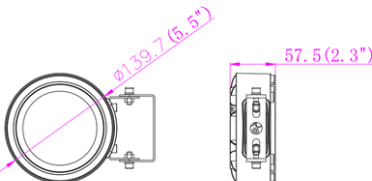



256-801-9825

LED Flood Light

SPECIFICATIONS

OPTICAL	Input Power (Tolerance : ±10%)	35W		
	Color Temperature(Color Tunable)	3000K	4000K	5000K
	Lumen (Tolerance : ±10%)	4726.5 LM	5184.0 LM	5121.0 LM
	Efficacy (Tolerance : ±3%)	127.50 LM/W	144.24LM/W	135.37LM/W
	CRI	>80		
	Color Consistency	<7 Steps (or <7 SDCM)		
	Distribution Pattern	Clear Tempered Glass		
	Beam Angle (10%) (Tolerance : ±15%)	110 Degree		
ELECTRICAL	Input Voltage and Frequency	120-277VAC 50/60Hz		
	PF (Tolerance : -3%)	≥0.9		
	THD (Tolerance : +5%)	≤20%		
	Flicker Percent	<70%		
	Driver Brand	HBE		
	Driver Model	HB-LFL61-035G-52		
	Driver Surge protection	L/N-PE: 2.0kV, L-N: 2.0kV		
	Dimming	0-10V dimming standard		
	Optional Accessory	DC Photocontrol		
MATERIALS	LED Brand	Lumileds		
	LED Type	SMD2835		
	LED QTY	45 PCS*2		
	Housing	Die-cast aluminum		
	Housing Color	Brown, Black, or Customized		
	EPA	0.28 ft ²		
OTHERS	Waterproof Rating	WET (IP65)		
	Operating Temperature	-40°C TO 45°C		
	Storage Temperature	-40°C TO 80°C		
	Operating Humidity	20% - 90% RH		
	Storage Humidity	20% - 90% RH		
	Warranty	5 years warranty with 24/7 operating hours Luminaire lifetime at 25°C.		

LED Flood Light

PACKAGE

Bracket Type	Carton Size		Qty / Carton	Net Weight / Carton	Gross Weight / Carton
AM YM	Outer box	420*387*295mm	10PCS	9.6KG	12.39KG
	Inner box	275*185*85mm	10PCS	0.96KG	1.14KG

Tolerance of Carton Size: ± 15 MM, Tolerance of Weight: $\pm 10\%$.

Inner box

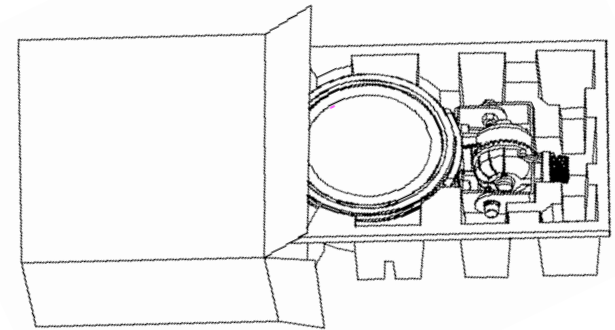
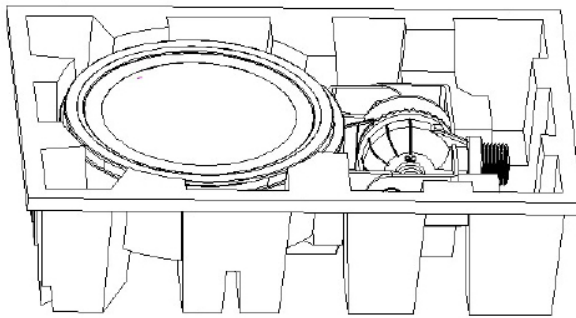

Outer box

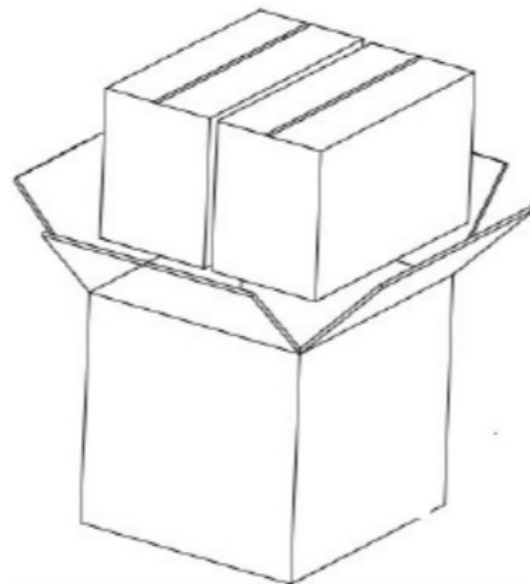

LED Flood Light

LIGHT DISTRIBUTION TESTING PARAMETERS

Luminaire Property

Luminaire Manufacturer:

Luminaire Category:

Lamp Catalog:

Number of Lamps:

Luminous Length (mm): -110

Luminous Height (mm):

Current: 0.310 A

Power Factor: 0.996

Luminaire Description:

Lamp Description:

Lumens per Lamp:

Luminous Width (mm): -110

Voltage: 120.0 V

Power: 37.07 W

Photometric Results

IES Classification: Type II

Total Rated Lamp Lumens: 4726.5 lm

Efficiency: 100%

Upward Ratio: 0%

C0r0 Intensity: 1691.8 cd

Pos of Max. Intensity: H135 V1

Beam Angle(C0/C180,C90/C270,C45/C225,C135/315): 113.6, 113.9, 113.9, 113.7

Longitudinal Classification: Very Short

Measurement Flux: 4726.5 lm

Downward Ratio: 100%

Luminaire Efficacy Rating (LER): 127.55

Max. Intensity: 1694.35 cd

Luminous Intensity Distribution Curve

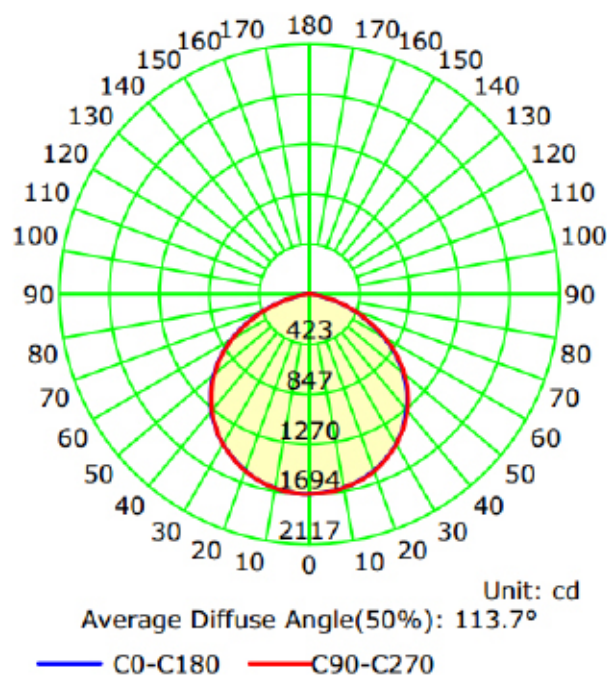

The Average Illuminance Effective Figure

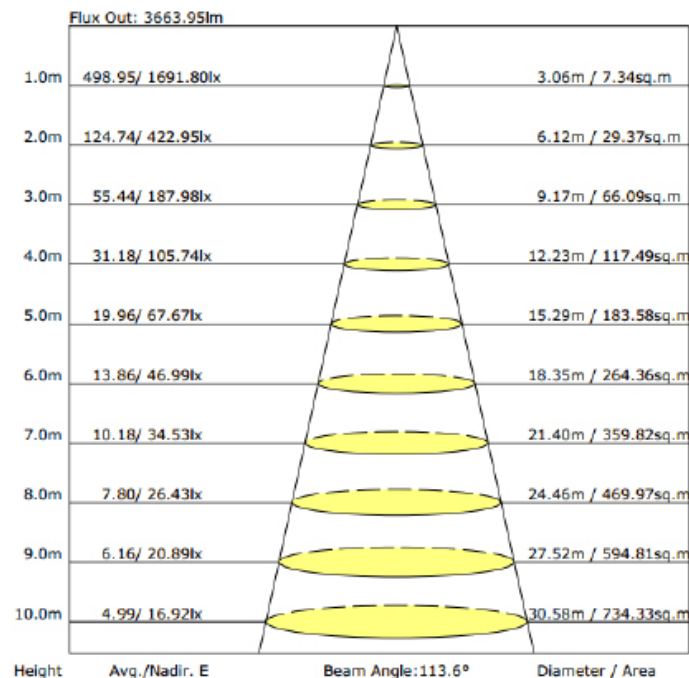



256-801-9825

LED Flood Light

NOTICE FOR USER

- Please turn off power before install or change assembly parts
- The input voltage and luminaire should be matched, after connecting the power line, Please make sure the wiring section is insulated.
- No-professionals, must not install and disassemble the luminaire

TROUBLE SHOOTINGS

Troubles	Check points
Flickering of the light	Turn off the power and turn on again in 3 minutes.
If same phenomena occur, then call agencies.	345*300*345 mm

Wattage adjustable instruction

Turn the wattage adjustable knob to a certain wattage gear, the power of the lamp will change to the corresponding wattage.

Wattage adjustable range 30%-95%.

Note: Please turn off the power before adjusting the wattage.