



ISCDL Series: Commercial Downlights

5 Color Selectable + 3 Wattage Selectable

Project :

Type :

Part#:

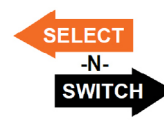

Commercial Downlights



Mounting & Installations:

- Cut Out Dimensions:
 - 4": 4-7/8"
 - 6": 6-1/8" – 7-3/16"
 - 8": 7-1/2" – 8-7/8"
 - 10: 9" -- 10"
- Optional new construction plate available
- This fixture does not fit into a recessed can
- No housing needed in remodel applications, tension clips mount into 1/2" to 1.5" thick ceiling
- Can be removed from below the ceiling for service or replacement
- Pre-wired junction box with circuit wiring built in (3 in / 3 out)

Certifications:

- ETL Listed for USA and CA
- Energy Star Certified
- CA Title 24 JA8-2022 CEC Listed
- 5 Year Limited Warranty
- FCC CFR 47, GCC Part 15, Subpart B:2017
- IC Rated and ASTM-E283 Air-Tight
- Complies with UL 263, ASTM E119, CAN ULC S101

IS CMD Series

Detail Specifications:

- Finish: White Smooth Standard
 - Black & Clear- Specular Haze Trims Available
- Wet Location Rated
- Beam Angle:
 - 4, 6, 8": 80°
 - 10": 90°
- Chip: SMD 2835, R9 >50, CRI >90
- 3 Step MacAdam Ellipses
- Operating Temperature: -40° - 114° F
- Lens: Frosted PC, non-yellowing
- Average life (L70) of 70,000 hours

Applications:

- General Recessed Lighting
- Residential & Multifamily
- Office, Hallways and Meeting Rooms
- Education, Healthcare, Retail, Hospitality
- Commercial Lighting

Product Information:

- Metal housing and trim for better heat dissipation
- 27" integral flex whip included on each fixture
- Carabiner safety clip on each fixture
- SnapTrim Canless: Spring clips with remote j-box eliminates can
- Standard white round trim included: optional trims available
- Deep reflector lens reduces glare and optimizes even beam distribution
- Select-n-Switch Technology: 5-CCT + 3-Power Selectable

Driver Options:

- UNV: 120-277V 0-10V Dimmable
- HV: 220-480V 0-10V Dimmable
- Built in 10Kv Surge Protector
- DMX512 dimming standard for theatrical effects
- Compatible with Synapse Wireless & AVI-ON controls
- THD: <20% (+/-5% tolerance), PF >0.9, 50/60Hz

ISCDL Series: Commercial Downlights

5 Color Selectable + 3 Wattage Selectable

Series	Voltage	Emergency
ISCDL4-3WS19CS5 4" 9/14/19W • 750/1,000/ 1,500LM	UNV 120-277V	Blank None
ISCDL6-3WS19CS5 6" 9/13/19W • 800/1,200/ 1,600LM	HV¹ 347-480V	EMB Emergency Backup
ISCDL8-3WS29CS5 8" 16.5/23/29W • 1,500/2,000/ 2,500LM		
ISCDL10-3WS38CS5 10" 21/30/38W • 2,000/2,500/ 3,300LM		

1. HV: Step down transformer into 4" j-box

Optional Accessories (Order Separately)

Trim	Goof Ring	New Construction Plates	15W Emergency ¹ Backup	Junction Box
ISCDL-TR4-HZSM 4" Clear- Specular Haze Smooth	GR4-WH 4-8" Width	ISCUNV-NC-ICAT-7H Universal plate w/ hanging bars	ISCDLEM-25-HV-0/10-2P 25W Emergency Backup	ISJBOX-AL Junction box with 4 1/2" knockouts
ISCDL-TR4-BLKSM 4" Black Smooth	GR6-WH 6.3-10" Width	ISCUNV-JBX-RI-XL Universal tough in plate. Extra long.		
ISCDL-TR6-HZSM 6" Clear- Specular Haze Smooth	GR8-WH 8-12.5" Width	ISC4-NC-RI-J-JBX 4" plate w/ hanging bars + j-box		
ISCDL-TR6-BLKSM 6" Black Smooth	GR10-WH 9-14.1" Width	ISC6-NC-RI-J-JBX 6" plate w/ hanging bars + j-box		
ISCDL-TR8-HZSM 8" Clear- Specular Haze Smooth		ISC8/10-NC-RI-J-JBX 8 & 10" plate w/ hanging bars + j-box		
ISCDL-TR8-BLKSM 8" Black Smooth				
ISCDL-TR10-HZSM 10" Clear- Specular Haze Smooth				
ISCDL-TR10-BLKSM 10" Black Smooth				

1. Field installable. Lasts 90 minute

FEATURES

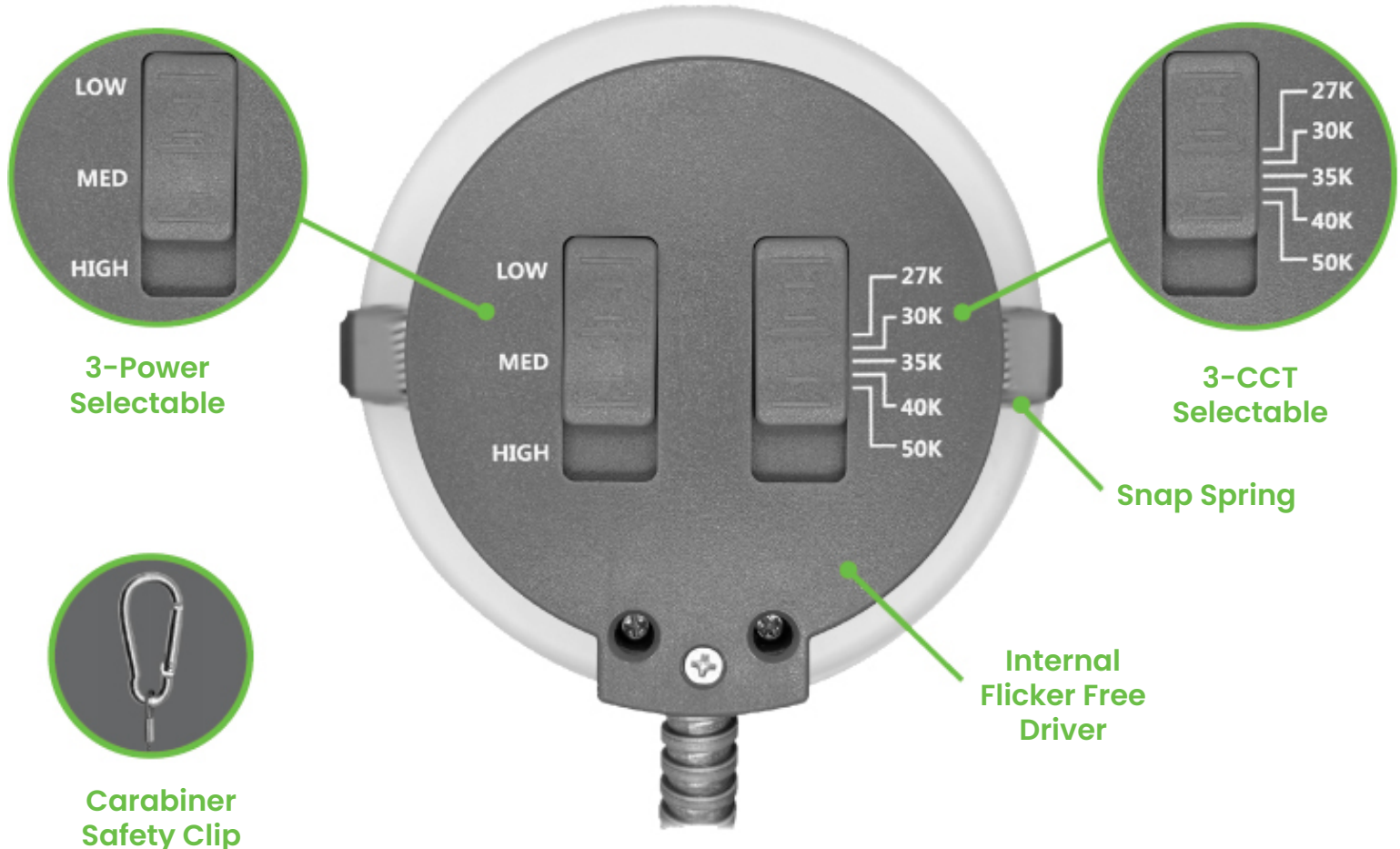

ISCDL Series: Commercial Downlights

5 Color Selectable + 3 Wattage Selectable

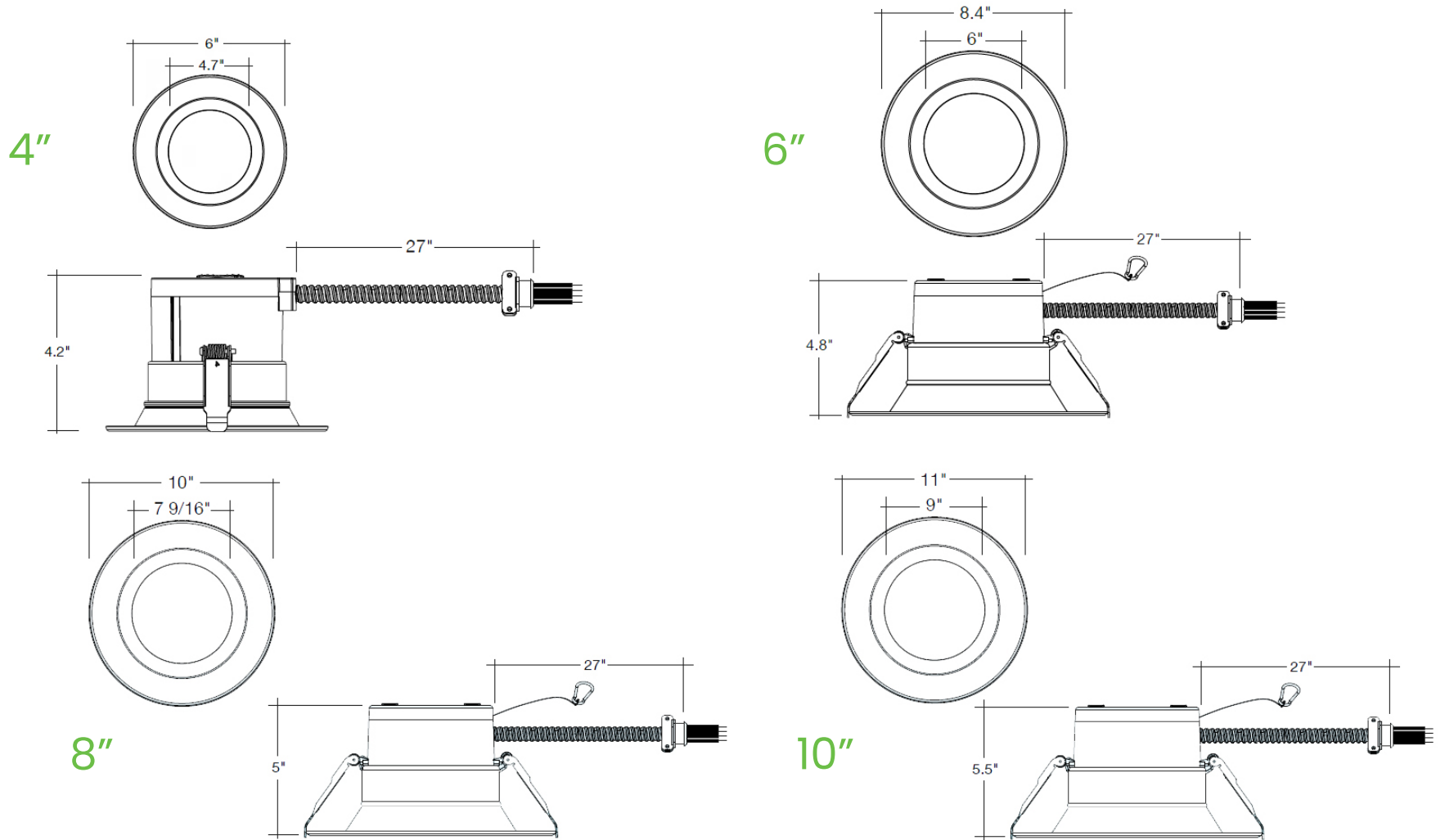

Model	Voltage	Watts	Lumens	Color	CRI
ISCDL4-3WSI9CS5	120-277V	9/14/19w	750/1000/1500lm	27/30/35/40/50K	>90
ISCDL6-3WSI9CS5	120-277V	9/13/19w	800/1200/1600lm	27/30/35/40/50K	>90
ISCDL8-3WS29SC5	120-277V	16.5/23/29w	1500/2000/2500lm	27/30/35/40/50K	>90
ISCDL10-3WS38CS5	120-277V	21/30/38w	2000/2500/3300lm	27/30/35/40/50K	>90

ISCDL Series: Commercial Downlights

5 Color Selectable + 3 Wattage Selectable

TRIMS

Model	Description
ISCDL-TR4-HZSM	4" Clear-Specular Haze Reflector
ISCDL-TR4-BLKSM	4" Black Reflector
ISCDL-TR6-HZSM	6" Clear-Specular Haze Reflector
ISCDL-TR6-BLKSM	6" Black Reflector
ISCDL-TR8-HZSM	8" Clear-Specular Haze Reflector
ISCDL-TR8-BLKSM	8" Black Reflector
ISCDL-TR10-HZSM	10" Clear-Specular Haze Reflector
ISCDL-TR10-BLKSM	10" Black Reflector

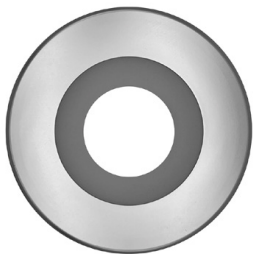

ISCDL-TR4-HZSM
ISCDL-TR6-HZSM
ISCDL-TR8-HZSM
ISCDL-TR10-HZSM

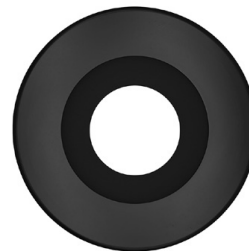

ISCDL-TR4-BLKSM
ISCDL-TR6-BLKSM
ISCDL-TR8-BLKSM
ISCDL-TR10-BLKSM

GOOF RINGS

Model	Description
GR4-WH	4" Goof Ring, Inner Dim: 4" Outer Dim: 8"
GR6-WH	6" Goof Ring, Inner Dim: 6.3" Outer Dim: 10.5"
GR8-WH	8" Goof Ring, Inner Dim: 8" Outer Dim: 12.5"
GR10-WH	10" Goof Ring, Inner Dim: 9" Outer Dim: 14.1"

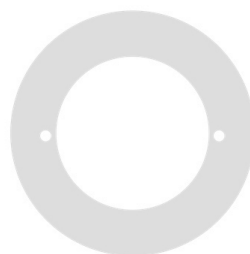

GR4-WH
GR6-WH
GR8-WH
GR10-WH

ISCDL Series: Commercial Downlights

5 Color Selectable + 3 Wattage Selectable

NEW CONSTRUCTION PLATES

Model	Description
ISCUNV-NC-ICAT-7H	Universal plate w/ hanging bar
ISCUNV-JBX-RI-XL	Universal tough in plate. Extra long
ISC4-NC-RI-J-JBX	4" plate w/ handing bards + j-box
ISC6-NC-RI-J-JBX	6" plate w/ handing bards + j-box
ISC8/10-NC-RI-J-JBX	8" & 10" plate w/ handing bards + j-box

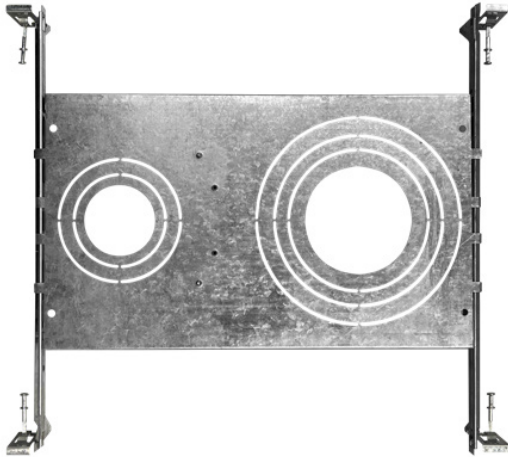

ISCUNV-NC-ICAT-7H
13 7/8" x 15 1/8"

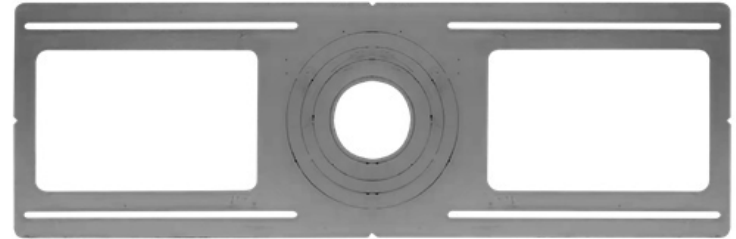

ISCUNV-JBX-RI-XL
7" x 26"

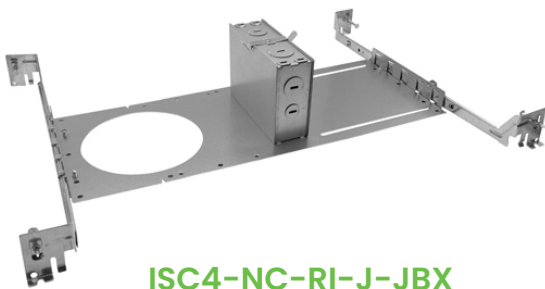

ISC4-NC-RI-J-JBX
17" W x 6.5" D x 3.5"H

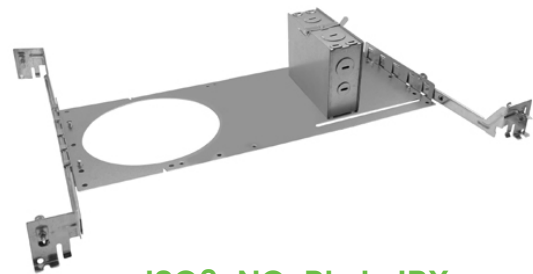

ISC6-NC-RI-J-JBX
18.5" W x 9" D x 4"H

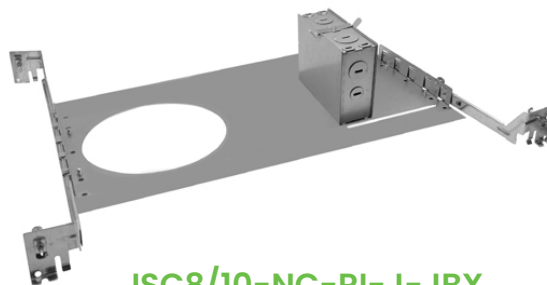

ISC8/10-NC-RI-J-JBX
18.5" W x 12" D x 4"H

ISCDL Series: Commercial Downlights

5 Color Selectable + 3 Wattage Selectable

15W EMERGENCY BACKUP

Model	Description
ISCDLEM-25-HV-0/10-2P	25W Emergency Backup

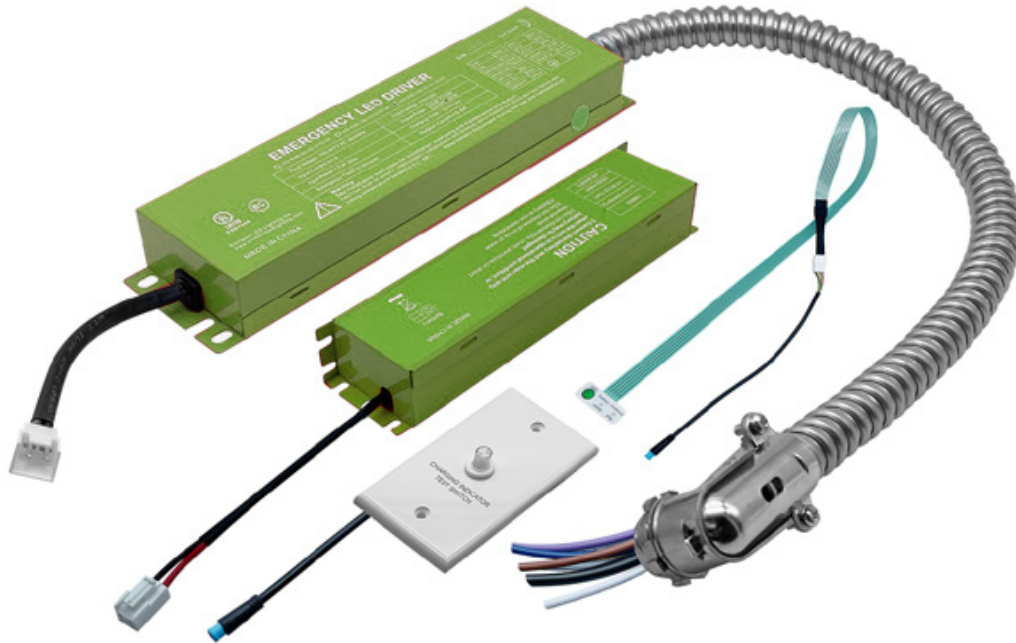

ISCDLEM-25-HV-0/10-2P

JUNCTION BOX

Model	Description
ISJBOX-AL	Junction box with 4 1/2" knockouts



ISJBOX-AL
4.46" W x 3.04" D x 1.37" H

ISCDL Series: Commercial Downlights

5 Color Selectable + 3 Wattage Selectable

TESTED COMPATIBLE DIMMERS

Other dimmers may be compatible but have not been tested.

Please contact us for more information.

4 & 6" Triac/ELV Dimmers

Lutron	Legrand	Leviton	Lutron	Insteon	Hubbell
S2-LH	HCL453PTCCCV6	ISD 600 I 120 / IPI06	NLV-600-WH	2477D	RSDE06
CT-603P(R)-WH		6633-PA	DVELV-300P-AL		
ISCDL8-3WS29CCTS5		6631-PLW	NTELV-300-WH		
ISCDL10-3WS38CS5			SELV-300P		

4, 6, 8, 10" 0-10V Dimmers

Lutron	Leviton	Synergy	Eaton	Hubbell
DVSTV-W	IP710-DLZ	ISD BC 120/277 WH	SF10P-W	PSD710
				RSD710Z